



# FUENTE ONDA COMPLETA REGULADA

**COD.: 2/2**

**" GARINS "**

FUENTE DE ALIMENTACION 2/2 "GARINS"

# ESQUEMA DE CONEXION E INSTALACION

TERMINALES PARA LA CONEXION A LA RED DE 220V 50 Hz.

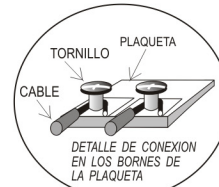
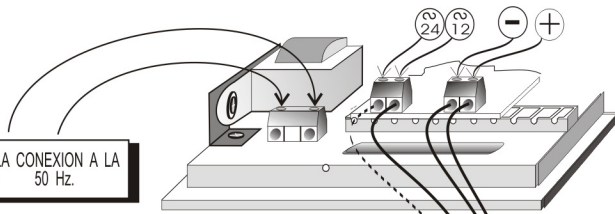

DETALLE DE CONEXION EN LOS BORNES DE LA PLAQUETA

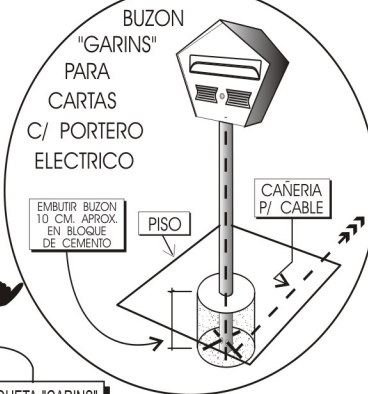

EMBITIR BUZON 13 CM. APROX. EN BLOQUE DE CEMENTO

PISO

CAÑERIA P/ CABLE

PLAQUETA "GARINS" DEL BUZON O DEL FRENTE DE CALLE  
Codigo 12/3 ó 12/4

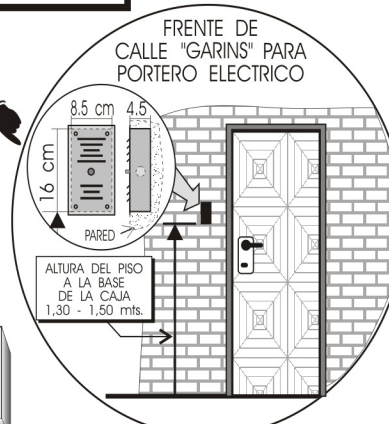

FRENTE DE CALLE "GARINS" PARA PORTERO ELECTRICO

8.5 cm  
4.5 cm  
16 cm

ALTURA DEL PISO A LA BASE DE LA CAJA 1.30 - 1.50 mts.

CAJAS DE CONEXION

CABLE INTERCOMUNICADOR DE 3 PARES

CERRADURA ELECTRICA  
Codigo 14/5

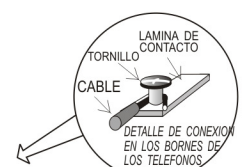
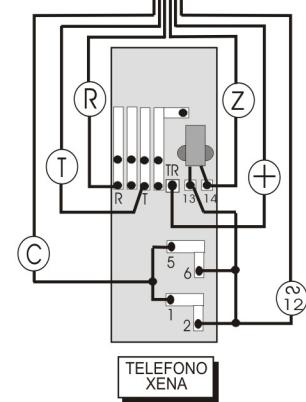
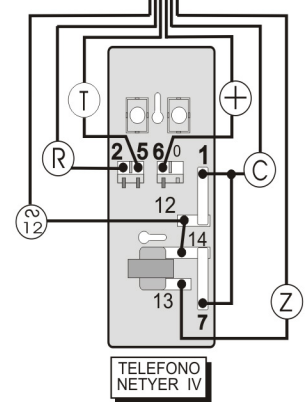
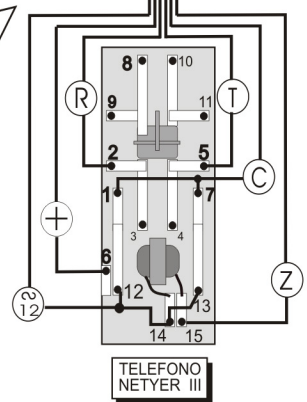
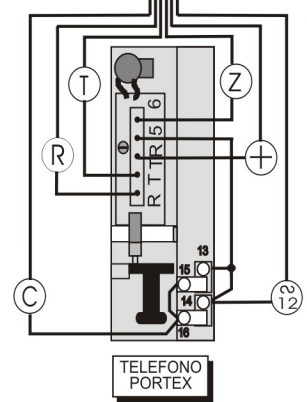
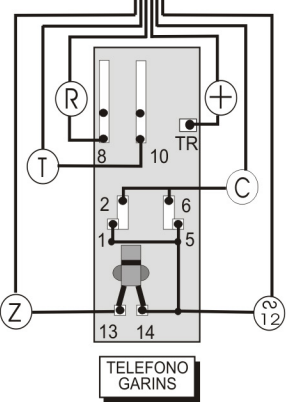

DETALLE DE CONEXION EN LOS BORNES DE LOS TELEFONOS